

Powered by



# HR 1251W ▶ 12V 51W

HR 1251W is specially designed for high efficient discharge application. Its characteristics are high energy density, small footprint and high discharge efficiency. It can be used for more than 260 cycles at 100% discharge in cycle service, up to 5 years in standby service.



## ► Specification

<b>Cells Per Unit</b>	6
<b>Voltage Per Unit</b>	12
<b>Capacity</b>	51W @15min-rateto1.67V per cell @25 °C (77°F)
<b>Weight</b>	Approx. 3.72 kg(8.2 lbs)
<b>Maximum Discharge Current</b>	150/180 A(5sec)
<b>Internal Resistance</b>	Approx. 13 mΩ
<b>Operating Temperature Range</b>	Discharge: -15 °C ~50°C ( 5 °F ~122°F) Charge: -15 °C ~40°C ( 5 °F ~104°F) Storage: -15°C ~40°C ( 5 °F ~104°F)
<b>Nominal Operating Temperature Range</b>	25°C ±3°C (77°F ±5°F)
<b>Float Charging Voltage</b>	13.5 to 13.8 VDC/unit Average at 25 °C (77°F)
<b>Recommended Maximum Charging Current Limit</b>	5.1A
<b>Equalization and Cycle Service</b>	14.4 to 15.0 VDC/unit Average at 25 °C (77°F)
<b>Self Discharge</b>	CSB Batteries can be stored for more than 6 months at 25°C (77°F). Please charge batteries before using. For high temperatures the time interval will be shorter.
<b>Terminal</b>	F1/F2-Faston Tab 187/250
<b>Container Material</b>	ABS (UL 94-HB/File E50263)*Flammability resistance of (UL 94-V0/File E88637) can be available upon request.



MH14533(N)



ISO 9001  
No.: 041005117



ISO 14001  
NO.UM 1-12-0045

CSB-manufactured VRLA batteries are UL-recognized components under UL924 and UL1989.

CSB is also certified by ISO9001 and ISO14001.

## ► Dimensions :

Unit: mm (inch)	Overall Height (H)	Container height (h)	Length (L)	Width (W)
	100.3±1.5 (3.95±0.06)	94.1±1.0 (3.70±0.04)	151.0±2.0 (5.94±0.08)	98.0±1.0 (3.86±0.04)

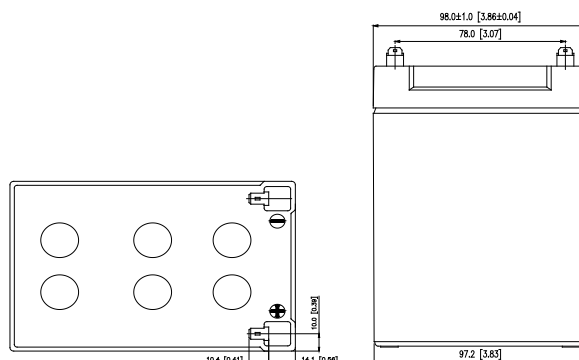
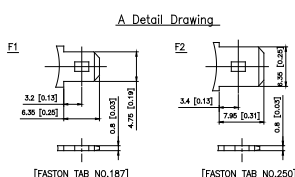
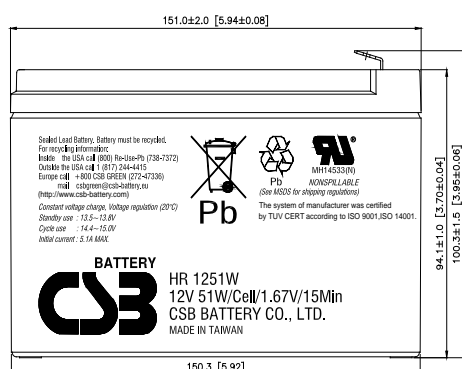

## Constant Current Discharge Characteristics Unit:A (25°C, 77°F)

F.V/Time	2MIN	4MIN	6MIN	8MIN	10MIN	15MIN	20MIN	30MIN	60MIN	90MIN
1.60V	85.8	64.0	50.8	43.0	36.8	27.1	21.4	15.4	8.33	6.65
1.67V	82.4	61.6	49.2	41.8	35.8	26.7	20.9	15.3	8.29	6.61
1.70V	80.5	60.5	48.0	41.2	35.2	26.4	20.7	15.2	8.28	6.58
1.75V	77.2	57.9	46.4	39.9	34.3	25.7	20.3	15.1	8.24	6.52
1.80V	72.9	54.8	44.6	38.3	32.9	24.8	19.9	14.9	8.20	6.44
1.85V	68.6	51.6	42.7	36.5	31.6	23.9	19.6	14.7	8.16	6.36

## Constant Power Discharge Characteristics Unit:W (25°C, 77°F)

F.V/Time	2MIN	4MIN	6MIN	8MIN	10MIN	15MIN	20MIN	30MIN	60MIN	90MIN
1.60V	1,030	768	607	511	441	325	257	185	100	79.8
1.67V	990	742	585	500	430	320	251	184	99.6	79.4
1.70V	969	726	573	494	422	317	249	183	99.3	79.0
1.75V	927	695	552	479	408	310	244	181	98.9	78.3
1.80V	875	657	532	460	393	300	239	179	98.4	77.3
1.85V	824	619	513	441	379	290	235	177	97.9	76.4

### Trickle (or Float) Service Life

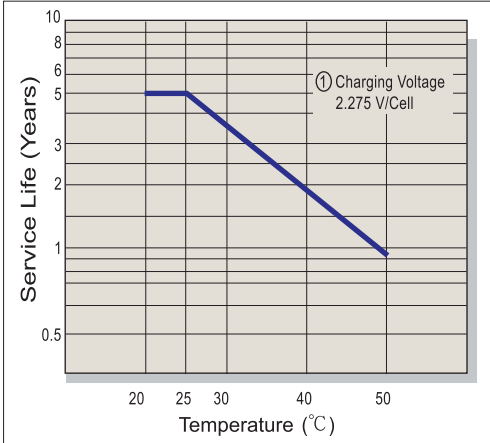

### Capacity Retention Characteristic

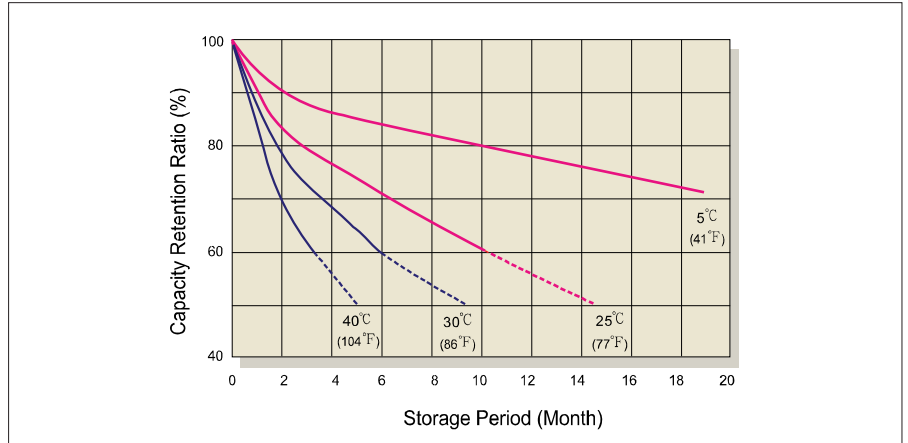

### Battery Voltage and Charge Time for Standby Use

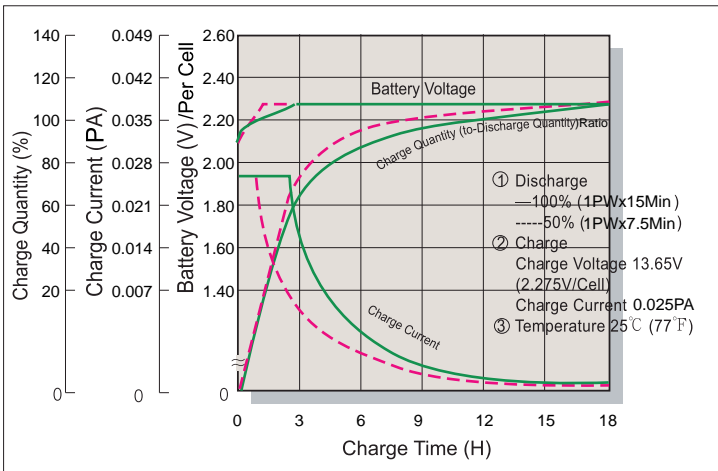

### Cycle Service Life

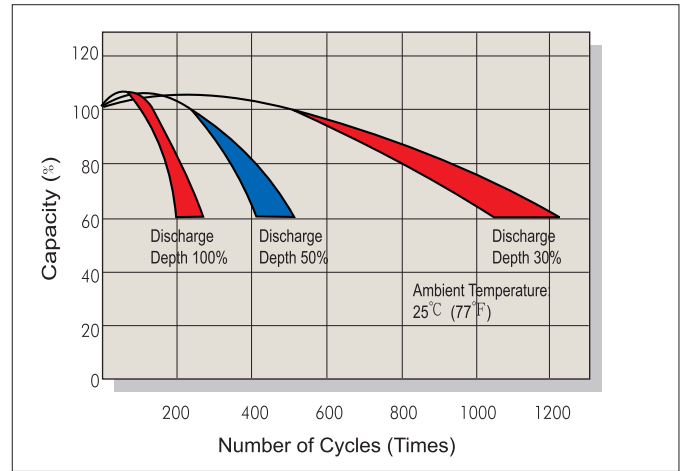

### Battery Voltage and Charge Time for Cycle Use

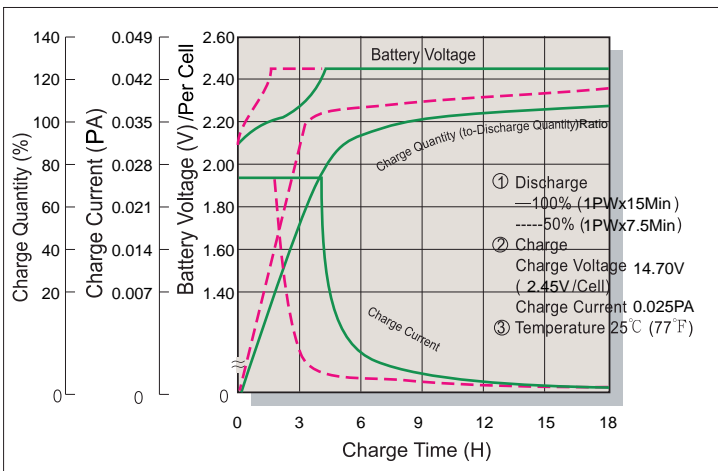

### Terminal Voltage (V) and Discharge Time

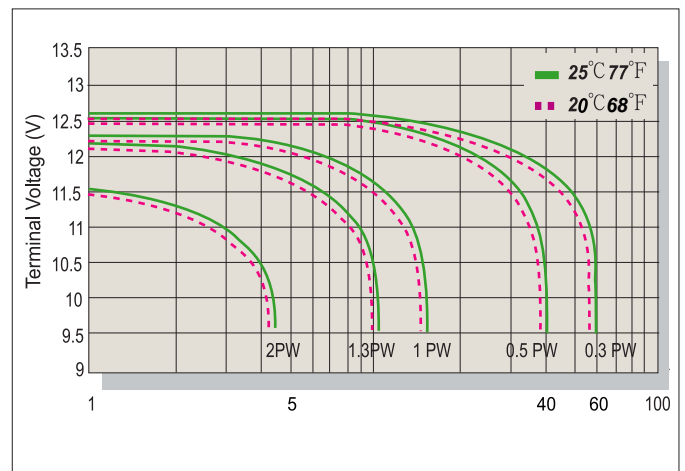

### Charging Procedures

Application	Charge Voltage (V/Cell)			Max. Charge Current
	Temperature	Set Point	Allowable Range	
Cycle Use	25°C (77°F)	2.45	2.40~2.50	0.1PA
Standby	25°C (77°F)	2.275	2.25~2.30	

### Discharge Current VS. Discharge Voltage

Final Discharge Voltage (V/Cell)	1.75	1.70	1.60	1.30
Discharge Power (W)	0.1P > (W)	0.1P ≤ (W) < 0.25P	0.25P ≤ (W) < 1.0P	(W) ≥ 1.0P

Sales Office URL: [WWW.CSB-BATTERY.COM](http://WWW.CSB-BATTERY.COM)

**GLOBAL HQ**  
 CSB BATTERY CO., LTD. (TAIWAN)  
 Tel : +886-2-2880-5600  
 Fax : +886-2-2888-3300  
 mail : service@csb-battery.com.tw

**BEIJING OFFICE. (CHINA)**  
 CSB BATTERY TECHNOLOGIES (BEIJING) CO., LTD.  
 Tel : +86-10-5820-5336/5338  
 Fax : +86-10-58203053  
 mail : chinasl@csb-battery.com

**AMERICA HQ**  
 CSB BATTERY TECHNOLOGIES INC. (U.S.A)  
 Tel : +1-817-244-7777/1-(800)3-CSB-USA(272872)  
 Fax : +1-817-244-4445  
 mail : csb@csb-battery.com

**SHANGHAI OFFICE. (CHINA)**  
 CSB BATTERY LOGISTIC (SHANGHAI) CO., LTD.  
 Tel : +86-21-5046-1622/5046-0833  
 Fax : +86-21-5064-3314  
 mail : chinasl@csb-battery.com

**EUROPE HQ**  
 CSB Battery Europe BV.  
 Tel : +31(0)-180-418-140  
 Fax : +31(0)-180-418-327  
 mail : eurosales@csb-battery.eu

**SHENZHEN OFFICE. (CHINA)**  
 CSB BATTERY LOGISTIC (SHANGHAI) CO., LTD.  
 Tel : +86-755-8831-6488/6396/6356  
 Fax : +86-755-8831-6548  
 mail : she@csb-battery.com.cn