

Powered by



# GPL 12880 ▶ 12V 88Ah

GPL 12880 is a general purpose battery up to 10 years in standby service or more than 260 cycles at 100% discharge in cycle service . As with all CSB batteries, all are rechargeable , highly efficient , leak proof and maintenance free.



## ► Specification

<b>Cells Per Unit</b>	6
<b>Voltage Per Unit</b>	12
<b>Capacity</b>	88 Ah @ 20hr-rate 1.75V per cell @25°C (77°F)
<b>Weight</b>	Approx.29.7 kg(65.48 lbs)
<b>Maximum Discharge Current</b>	800A(5sec)
<b>Internal Resistance</b>	Approx.4.5 mΩ
<b>Operating Temperature Range</b>	Discharge: -15°C~50°C ( 5°F~122°F) Charge: -15°C~40°C ( 5°F~104°F) Storage: -15°C~40°C ( 5°F~104°F)
<b>Nominal Operating Temperature Range</b>	25°C±3°C (77°F±5°F)
<b>Float Charging Voltage</b>	13.5 to 13.8 VDC/unit Average at 25°C (77°F)
<b>Recommended Maximum Charging Current Limit</b>	26.4A
<b>Equalization and Cycle Service</b>	14.4 to 15.0 VDC/unit Average at 25°C (77°F)
<b>Self Discharge</b>	CSB Batteries can be stored for more than 6 months at 25°C(77°F). Please charge batteries before using . For higher temperatures the time interval will be shorter.
<b>Terminal</b>	I2-Thread lead alloy recessed terminal to accept M6/M8 bolt
<b>Container Material</b>	Polypropylene(UL 94-V0/File E50955)*Flammability resistance of (UL 94-HB/File E216959) can be available upon request.



MH14533(N)



ISO9001  
No.:041005117



ISO 14001  
NO.UM 1-12-0045

CSB-manufactured VRLA batteries are UL-recognized components under UL924 and UL1989.

CSB is also certified by ISO9001 and ISO14001.

## ► Dimensions :

Overall Height (H)	Container height (h)	Length (L)	Width (W)
214.3±2.5 (8.44±0.1)	211.3±2.5 (8.32±0.1)	308.7±2.5 (12.15±0.1)	169±2 (6.65±0.08)

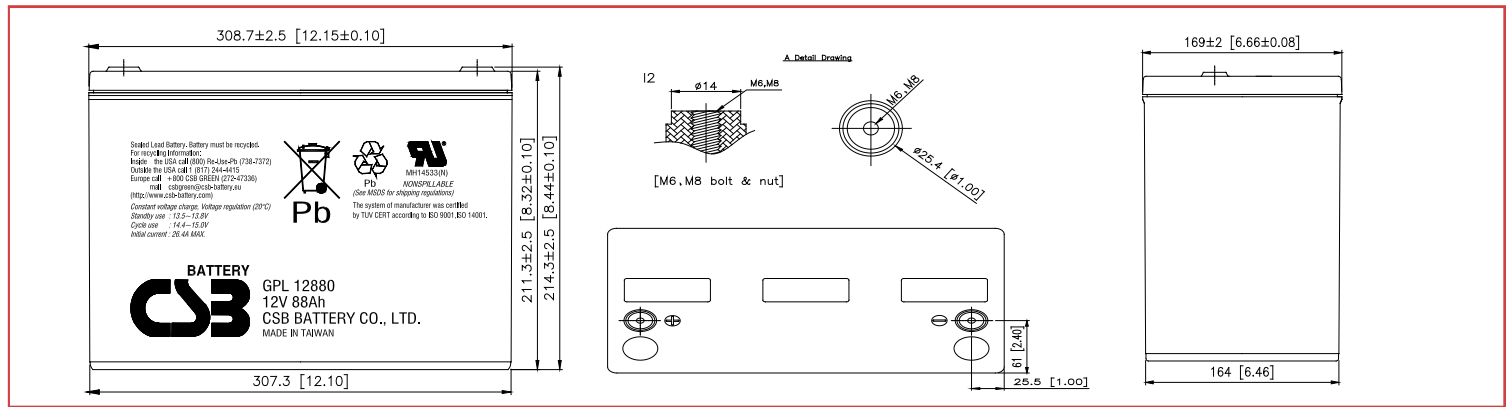

## Constant Current Discharge Characteristics Unit:A (25°C,77°F)

F.V/Time	5MIN	10MIN	15MIN	30MIN	60MIN	90MIN	2HR	3HR	5HR	8HR	10HR	20HR
1.60V	349	232	175	103	62.8	45.5	36.3	25.6	17.0	11.2	9.21	4.87
1.67V	321	225	171	102	62.4	45.2	36.0	25.5	16.9	11.1	9.12	4.84
1.70V	311	219	169	101	61.4	44.8	35.7	25.2	16.8	11.0	9.10	4.83
1.75V	274	199	163	99.0	60.3	43.9	35.1	25.1	16.6	10.9	8.96	4.74
1.80V	246	186	154	96.1	58.8	43.1	34.6	24.6	16.2	10.8	8.85	4.66
1.85V	215	170	138	90.3	55.8	41.0	32.9	23.8	15.8	10.4	8.51	4.48

## Constant Power Discharge Characteristics Unit:W (25°C,77°F)

F.V/Time	5MIN	10MIN	15MIN	30MIN	60MIN	90MIN	2HR	3HR	5HR	8HR	10HR	20HR
1.60V	3535	2496	1941	1177	720	535	434	306	203	136	110	58.3
1.67V	3307	2417	1919	1169	719	531	428	305	202	135	109	57.9
1.70V	3202	2373	1888	1166	716	529	426	304	201	134	108	57.8
1.75V	2995	2261	1828	1145	707	524	424	301	200	132	107	57.5
1.80V	2782	2129	1734	1113	694	516	418	298	198	130	106	57.1
1.85V	2434	1955	1581	1061	671	495	400	287	190	125	103	55.3

### Trickle (or Float) Service Life

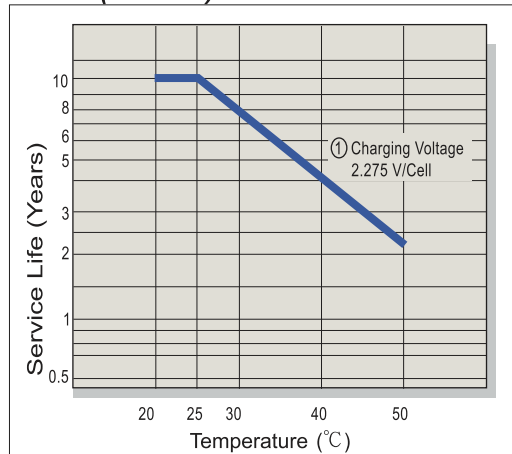

### Capacity Retention Characteristic

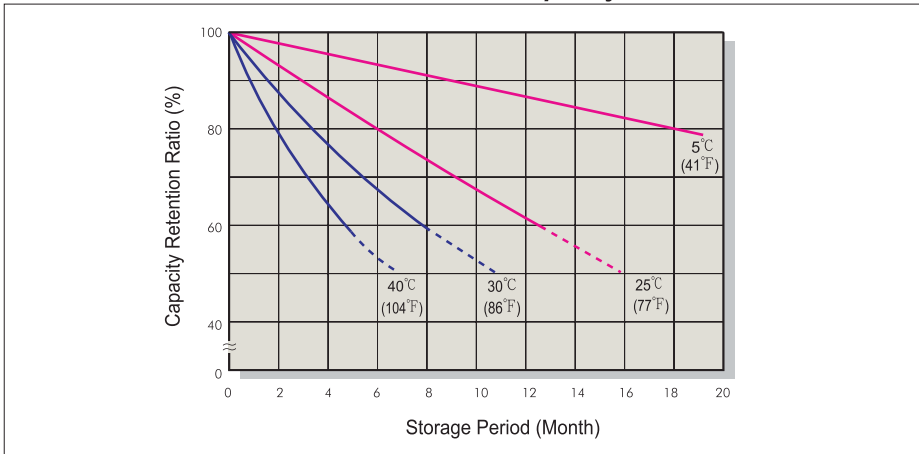

### Battery Voltage and Charge Time for Standby Use

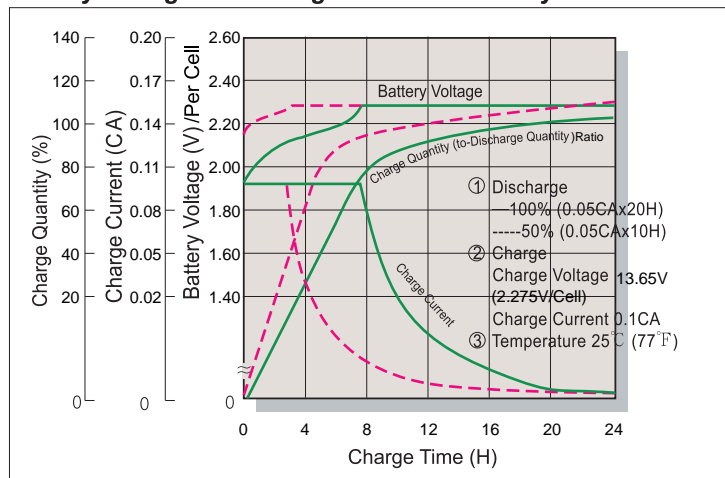

### Cycle Service Life

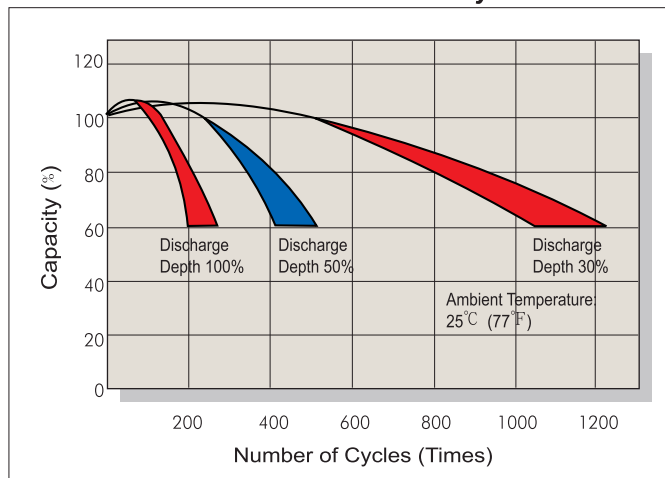

### Battery Voltage and Charge Time for Cycle Use

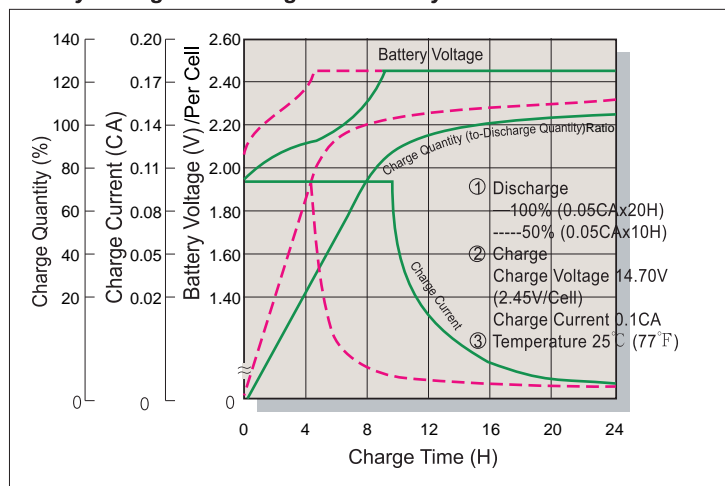

### Terminal Voltage (V) and Discharge Time

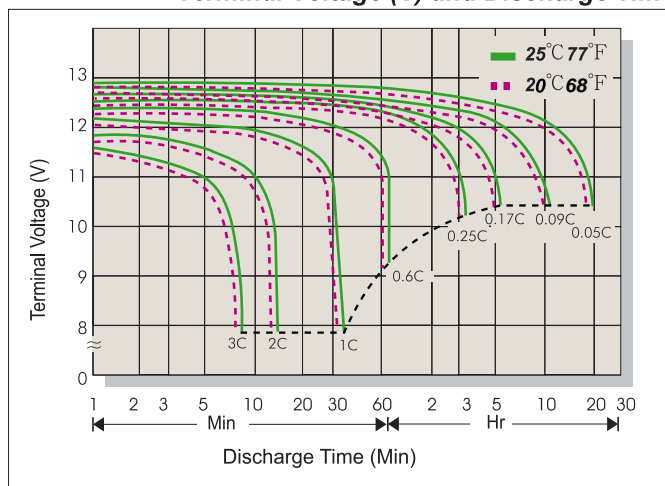

### Charging Procedures

Application	Charge Voltage(V/Cell)			Max.Charge Current
	Temperature	Set Point	Allowable Range	
Cycle Use	25°C (77°F)	2.45	2.40-2.50	0.3C
Standby	25°C (77°F)	2.275	2.25-2.30	

### Discharge Current VS. Discharge Voltage

Final Discharge Voltage V/Cell	1.75	1.70	1.60	1.30
Discharge Current(A)	0.2C>(A)	0.2C<(A)<0.5C	0.5C<(A)<1.0C	(A)>1.0C

Sales Office URL: [WWW.CSB-BATTERY.COM](http://WWW.CSB-BATTERY.COM)

**GLOBAL HQ**  
 CSB BATTERY CO., LTD. (TAIWAN)  
 Tel : +886-2-2880-5600  
 Fax : +886-2-2888-3300  
 mail : service@csb-battery.com.tw

**BEIJING OFFICE. (CHINA)**  
 CSB BATTERY TECHNOLOGIES (BEIJING) CO., LTD.  
 Tel : +86-10-5820-5336/5338  
 Fax : +86-10-58203053  
 mail : chinasl@csb-battery.com

**AMERICA HQ**  
 CSB BATTERY TECHNOLOGIES INC. (U.S.A)  
 Tel : +1-817-244-7777/1-(800)3-CSB-USA(272872)  
 Fax : +1-817-244-4445  
 mail : csb@csb-battery.com

**SHANGHAI OFFICE. (CHINA)**  
 CSB BATTERY LOGISTIC (SHANGHAI) CO., LTD.  
 Tel : +86-21-5046-1622/5046-0833  
 Fax : +86-21-5064-3314  
 mail : chinasl@csb-battery.com

**EUROPE HQ**  
 CSB Battery Europe BV.  
 Tel : +31(0)-180-418-140  
 Fax : +31(0)-180-418-327  
 mail : eurosales@csb-battery.eu

**SHENZHEN OFFICE. (CHINA)**  
 CSB BATTERY LOGISTIC (SHANGHAI) CO., LTD.  
 Tel : +86-755-8831-6488/6396/6356  
 Fax : +86-755-8831-6548  
 mail : she@csb-battery.com.cn